

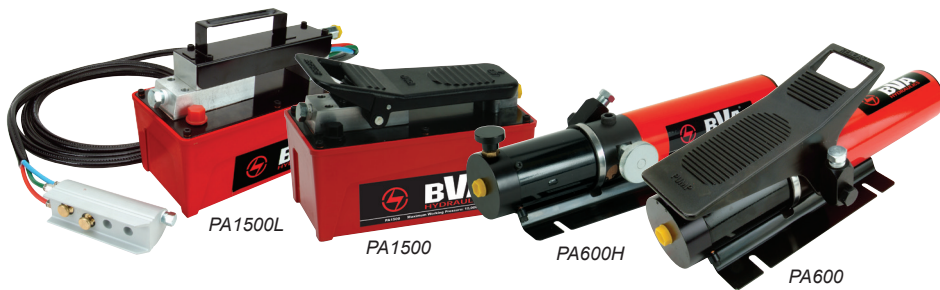

## Air Pumps

Air Actuated Power



### PA Series

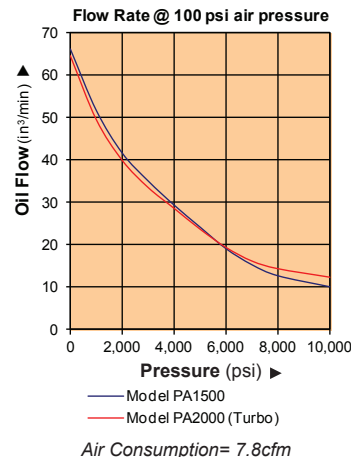

#### Product Information

- Metal reservoirs resist cracking
- US Patent No. 5,946,912, a built in bypass device protects the hydraulic system from over pumping damage
- A compact yet powerful Air Turbo Motor US Patent No. 5,341,723
- Suggested air inlet range: 110-175 psi / 7.6-12.1 bar
- Maximum working pressure: 10,000 psi / 700 Bar



#### PA1500A Pressure Adjustment



PA1500A Pressure can be adjusted externally from 1,000 to 10,000 psi.

Model Number	Usable Oil Capacity	Oil Outlet Port	Output Flow Rate		Input Air Pressure Required (psi)	Air Consumption (cfm)	Reservoir Construction
			No Load (in³/min)	Load (in³/min)			
<b>Single Acting</b>							
PA600	36.6	3/8"-18 NPTF	61	9	110-175	7.8	Steel
PA600H	36.6	3/8"-18 NPTF	61	9	110-175	7.8	Steel
PA1500	91.5	3/8"-18 NPTF	66	11	110-175	7.8	Aluminum
PA1500A*	91.5	3/8"-18 NPTF	66	11	110-175	7.8	Aluminum
PA1500L**	91.5	3/8"-18 NPTF	61	10	110-175	7.8	Aluminum
PA2000	122.1	3/8"-18 NPTF	65	12	110-175	7.8	Aluminum
PA3801	231.9	3/8"-18 NPTF	65	11	110-175	7.8	Steel
PA3801L**	231.9	3/8"-18 NPTF	61	10	110-175	7.8	Steel
PA7550	460.6	3/8"-18 NPTF	65	11	110-175	7.8	Steel
<b>Double Acting</b>							
PA1500M	91.5	3/8"-18 NPTF	66	11	110-175	7.8	Aluminum
PA3801M	231.9	3/8"-18 NPTF	65	11	110-175	7.8	Steel
PA7550M	460.6	3/8"-18 NPTF	65	11	110-175	7.8	Steel

1-888-332-6419

www.BVAhydraulics.com

\* This unit is equipped with an external pressure adjustment (1,000-10,000psi)

\*\*These pumps are equipped with a hand held air powered pendant



PA Series

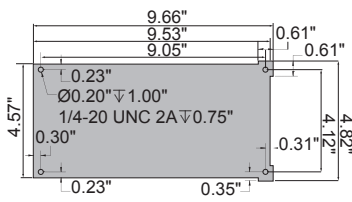
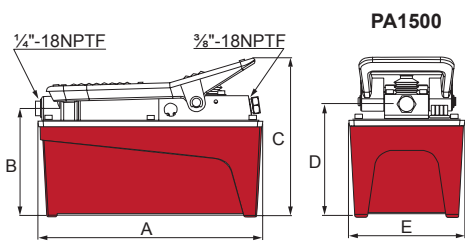
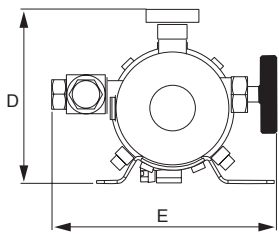
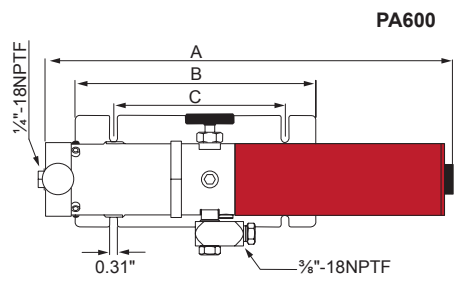

**FRL-145**  
 Use in compressed air lines upstream of all PA series air/hydraulic pumps to provide clean filtered (5um), lubricated air source to ensure long air motor life. Assembly is equipped with a metal bowl with sight glass and a 0-145 PSIG pressure gauge. 145 PSIG maximum working pressure. 3/8\" NPT Ports. Use Class-1 Turbine Oil (ISO VG32).

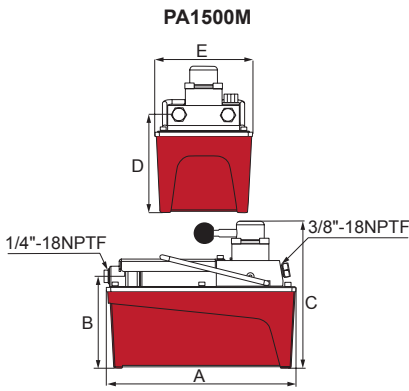
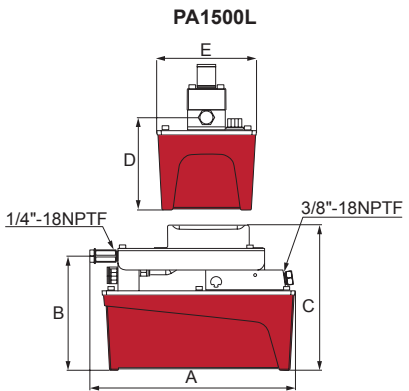

**AD-145**  
 Use in compressed air lines upstream of BVA FRL-145 and all PA series air/hydraulic pumps to remove 99% of free water from the air line to ensure long air motor life. 145 PSIG maximum working pressure. 3/8\" NPT Ports.

**Related Product: Hoses**  
 We offer a variety of hoses, fittings, lengths and materials.



pg 72

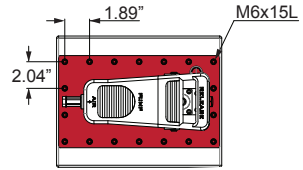
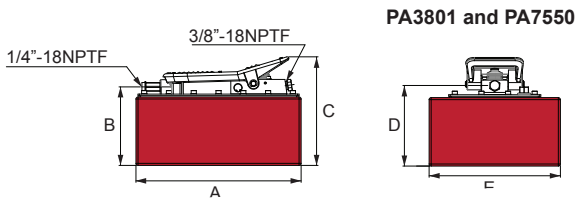

**Air Pump Combo**  
 Most air pumps are available in easy to order kits: pump, gauge, coupler, hose and cylinder



pg 64

Model Number	Base Mounting Holes	Dimensions (in)					Weight w/ Oil (lbs)
		A	B	C	D	E	
<b>Single Acting</b>							
PA600	yes	16.77	9.84	7.01	6.18	5.59	14.1
PA600H	yes	16.77	9.84	7.01	4.49	5.75	12.5
PA1500	yes	10.35	5.00	7.28	5.16	5.35	18.1
PA1500A*	yes	10.35	5.00	7.28	5.16	5.35	18.1
PA1500L**	yes	10.96	6.30	8.03	5.12	5.35	19.4
PA2000	yes	12.64	6.42	8.15	5.20	7.36	20.1
PA3801	no	12.64	5.08	7.36	5.24	7.36	27.1
PA3801L**	no	12.64	6.42	8.15	5.20	7.36	30.4
PA7550	no	12.64	5.00	8.31	6.14	8.43	36.0
<b>Double Acting</b>							
PA1500M	yes	10.51	5.00	7.99	5.35	5.35	19.1
PA3801M	no	12.64	5.04	8.03	5.31	7.36	24.0
PA7550M	no	12.64	5.98	9.02	6.34	10.04	40.0

\* Unit is equipped with an external pressure adjustment (1,000-10,000psi)  
 \*\*These pumps are equipped with a hand held air powered pendant